



UNIVERSITAS
GADJAH MADA



Smart Greenhouse

KKN-PPM UGM CANDIMULYO MAKARYO

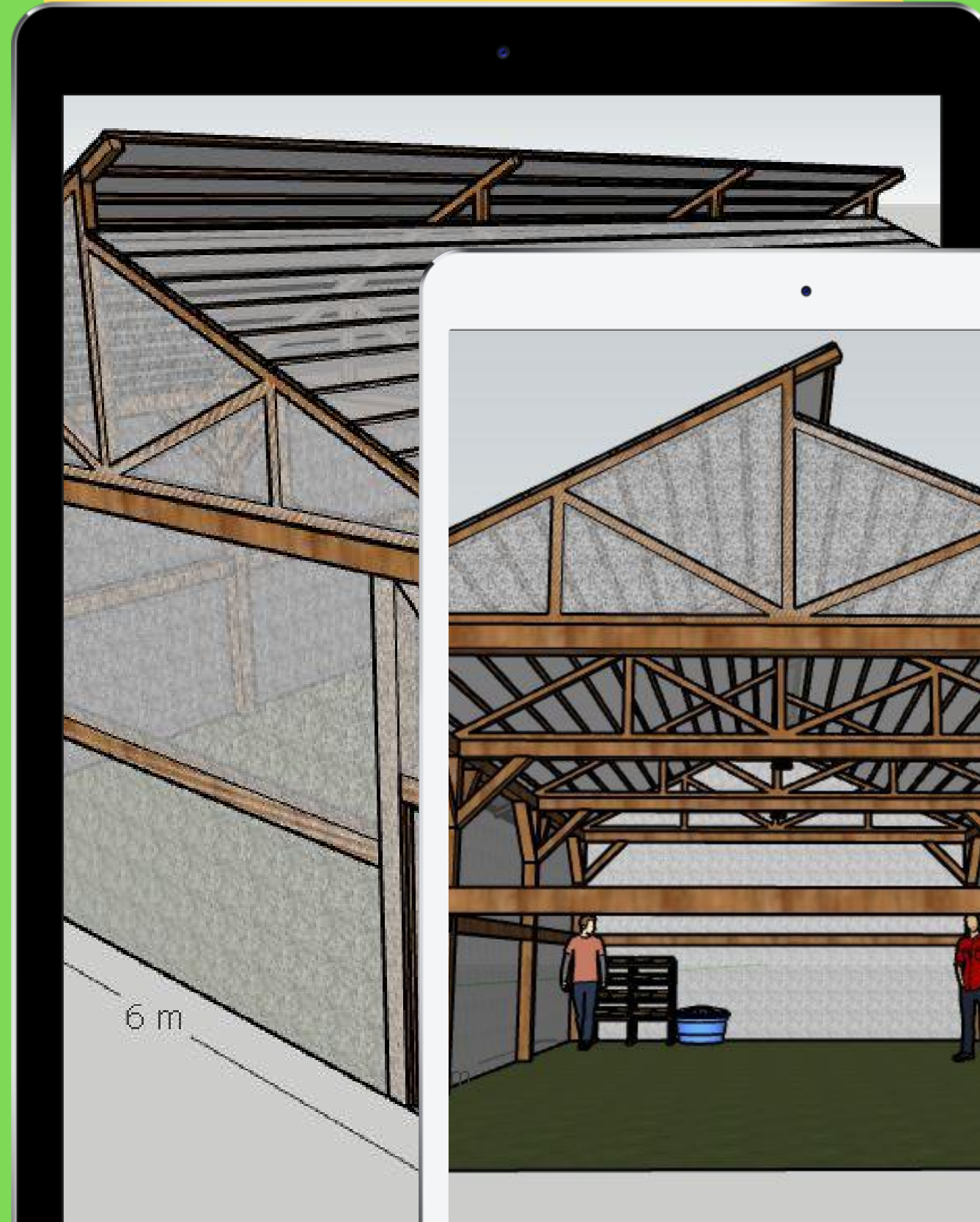



HASIL RANCANGAN

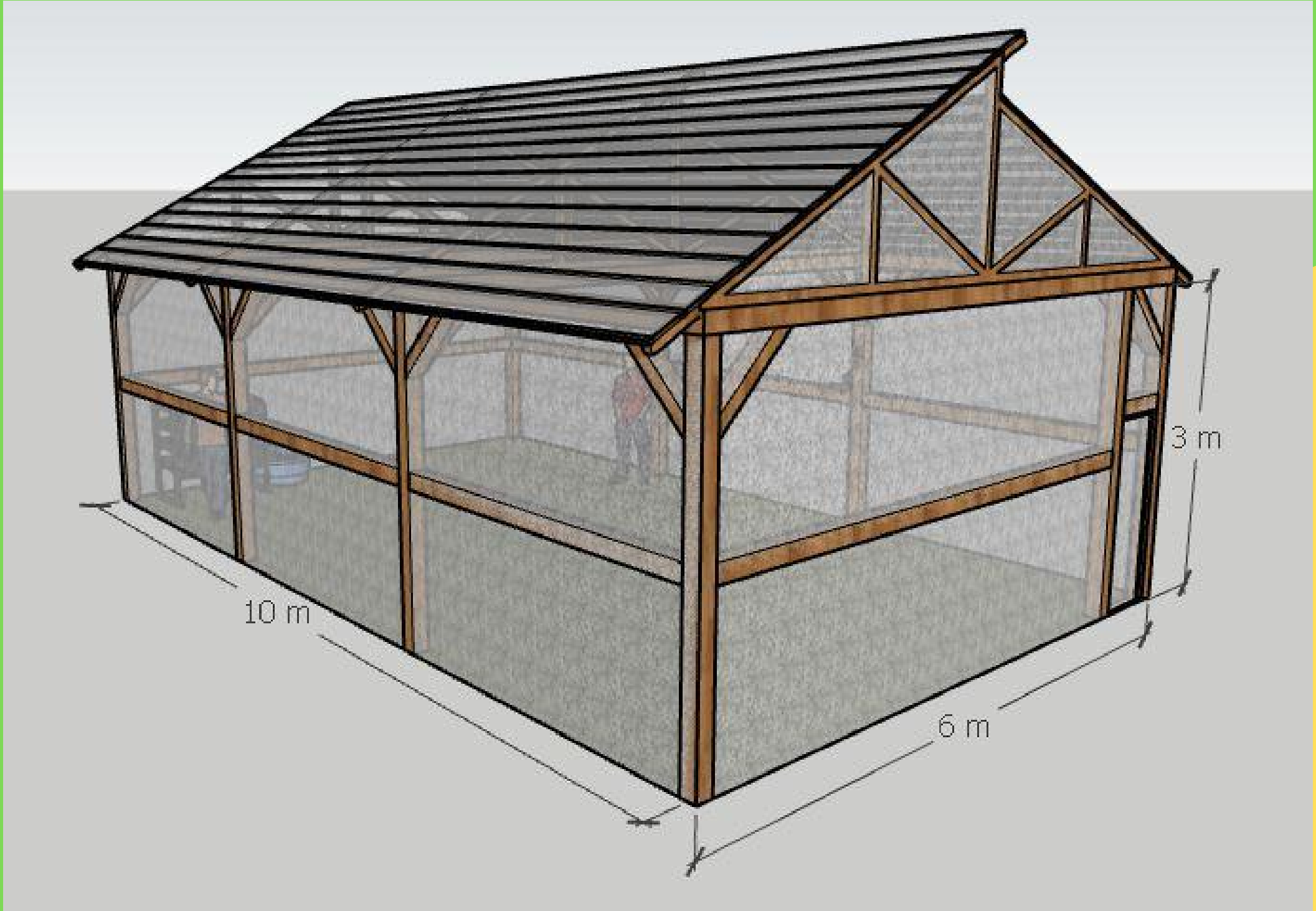

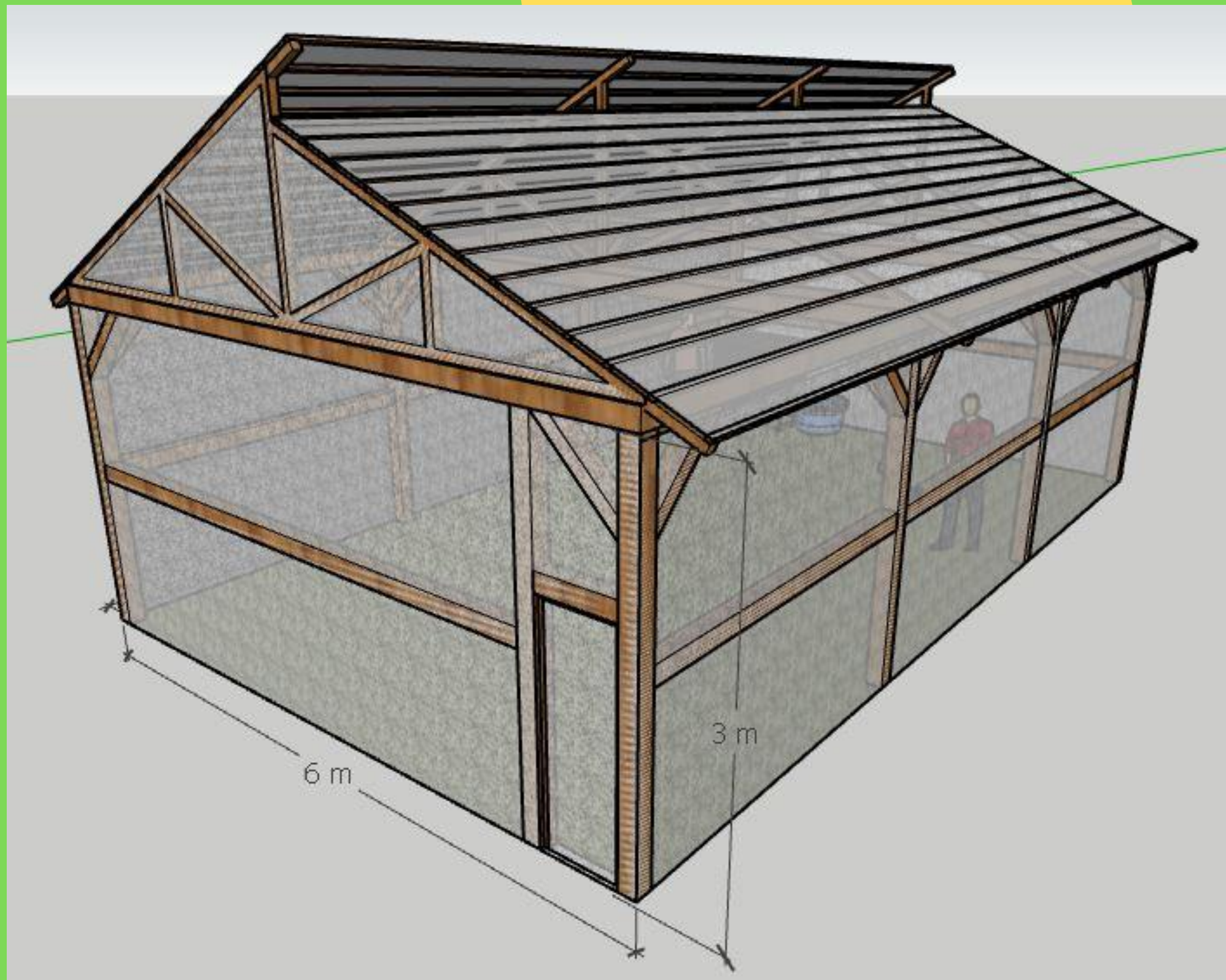

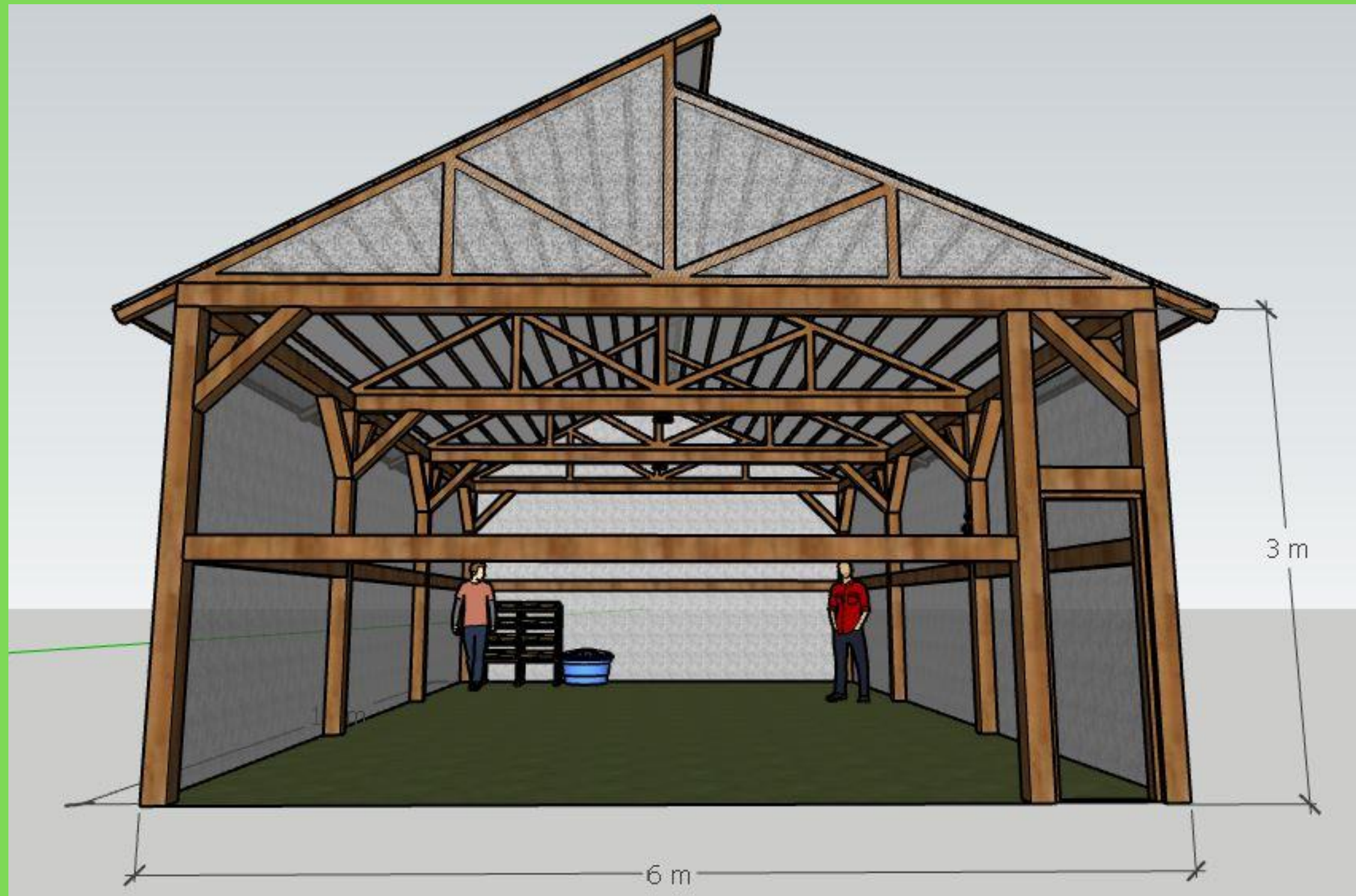



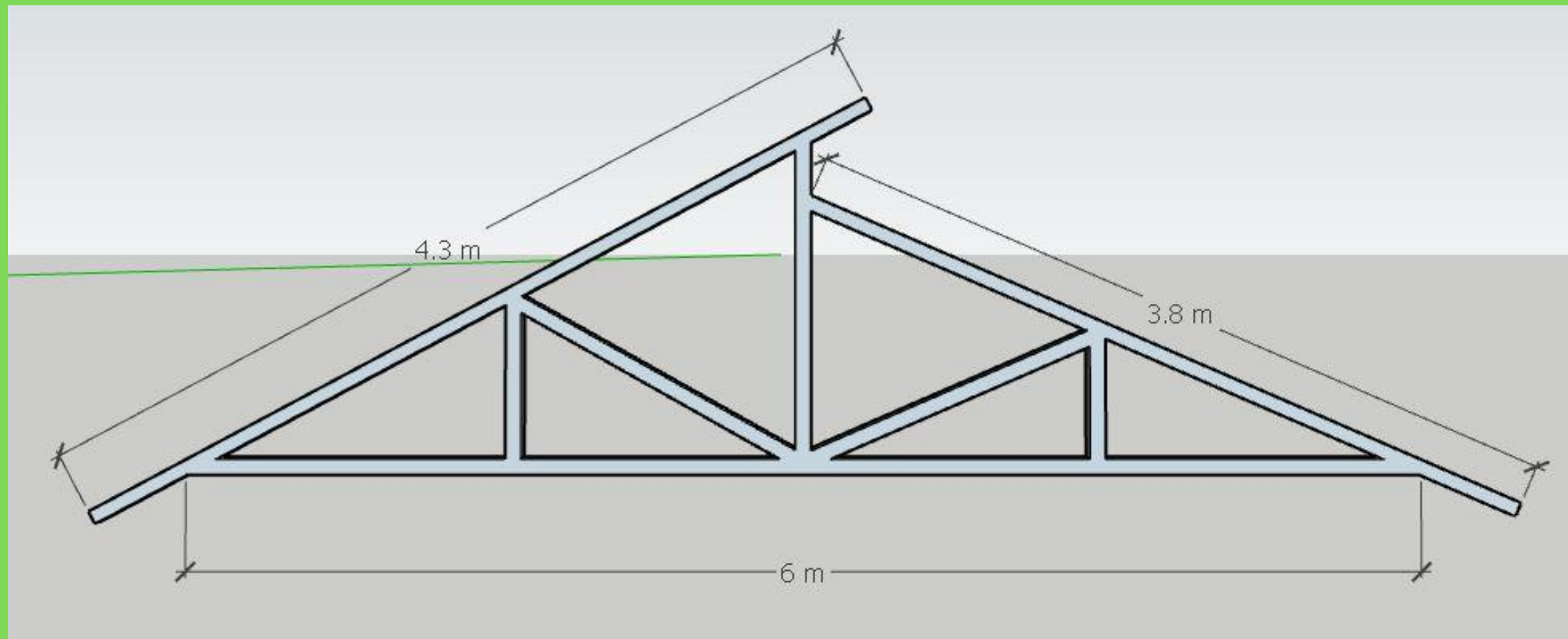

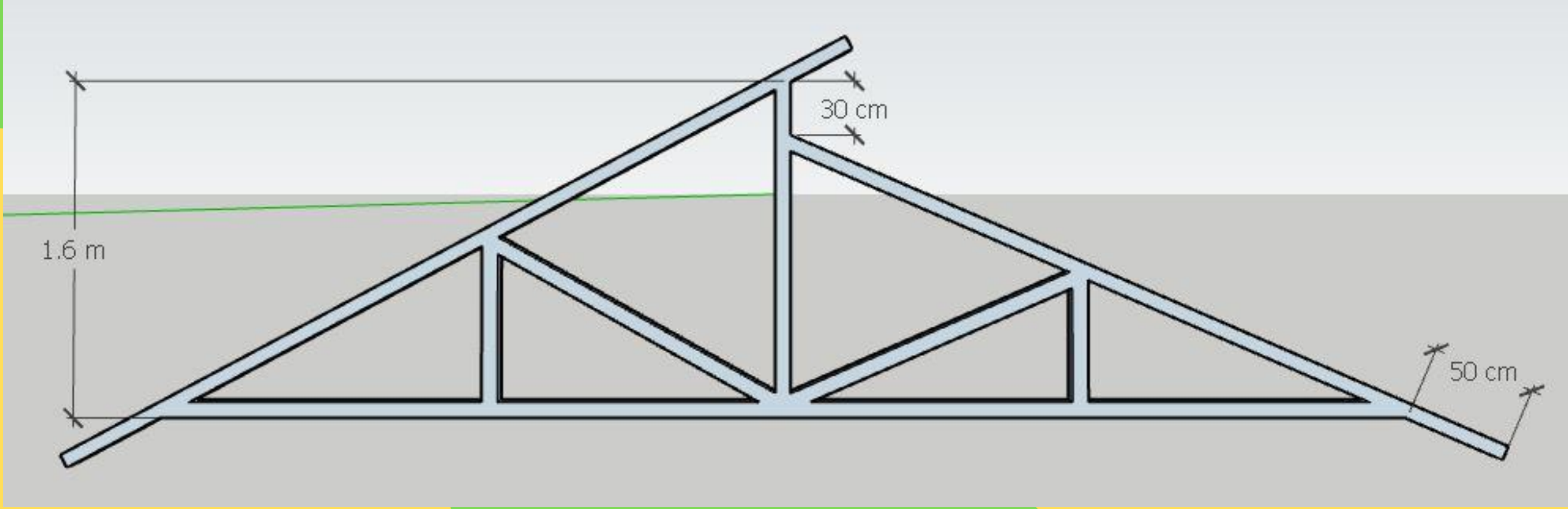

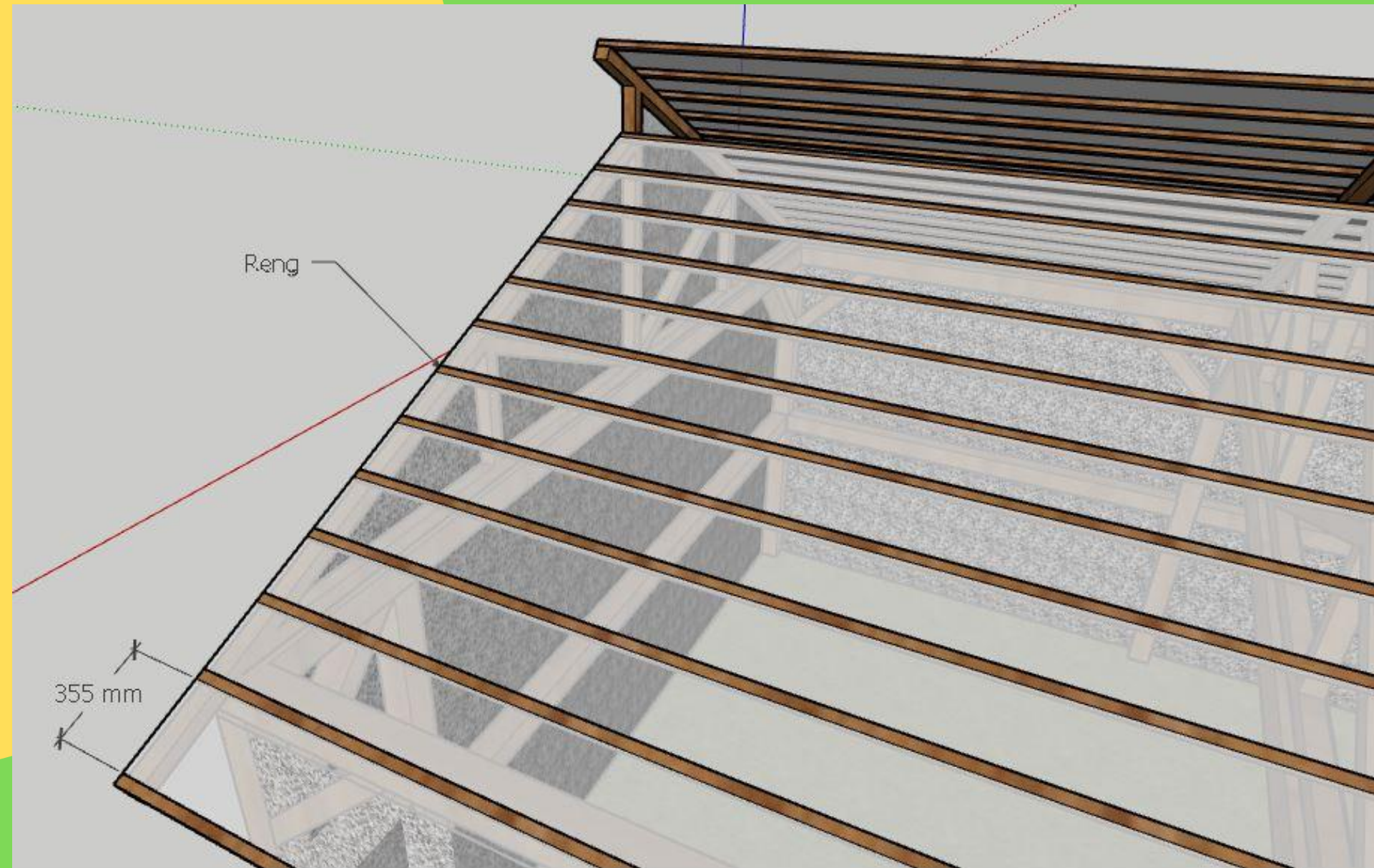





No	Uraian	Volume	Harga Satuan (Rp)	Jumlah (Rp)
Tiang				
1	Bambu dia. 12-18 cm, per 5 m	12 batang	50,000.00	600,000.00
Kuda-kuda atap, siku-siku dan reng				
2	Bambu dia. 8-9 cm, per 7 meter	16 batang	19,000.00	304,000.00
3	Bambu dia. 8-9 cm, per 10 meter	10 batang	25,000.00	250,000.00
Penutup Greenhouse				
4	Plastik UV 14%, ketebalan 200 mikron, lebar 4 m	10 m	50,000.00	500,000.00
5	Insect net, putih, lebar 3 m	35 m	60,000.00	2,100,000.00
Lain-lain				
6	Tali ijuk pengikat bambu, per 2.5 m	10 gulung	3,000.00	30,000.00
7	Paku	2 kg	20,000.00	40,000.00
Jumlah				3,824,000.00

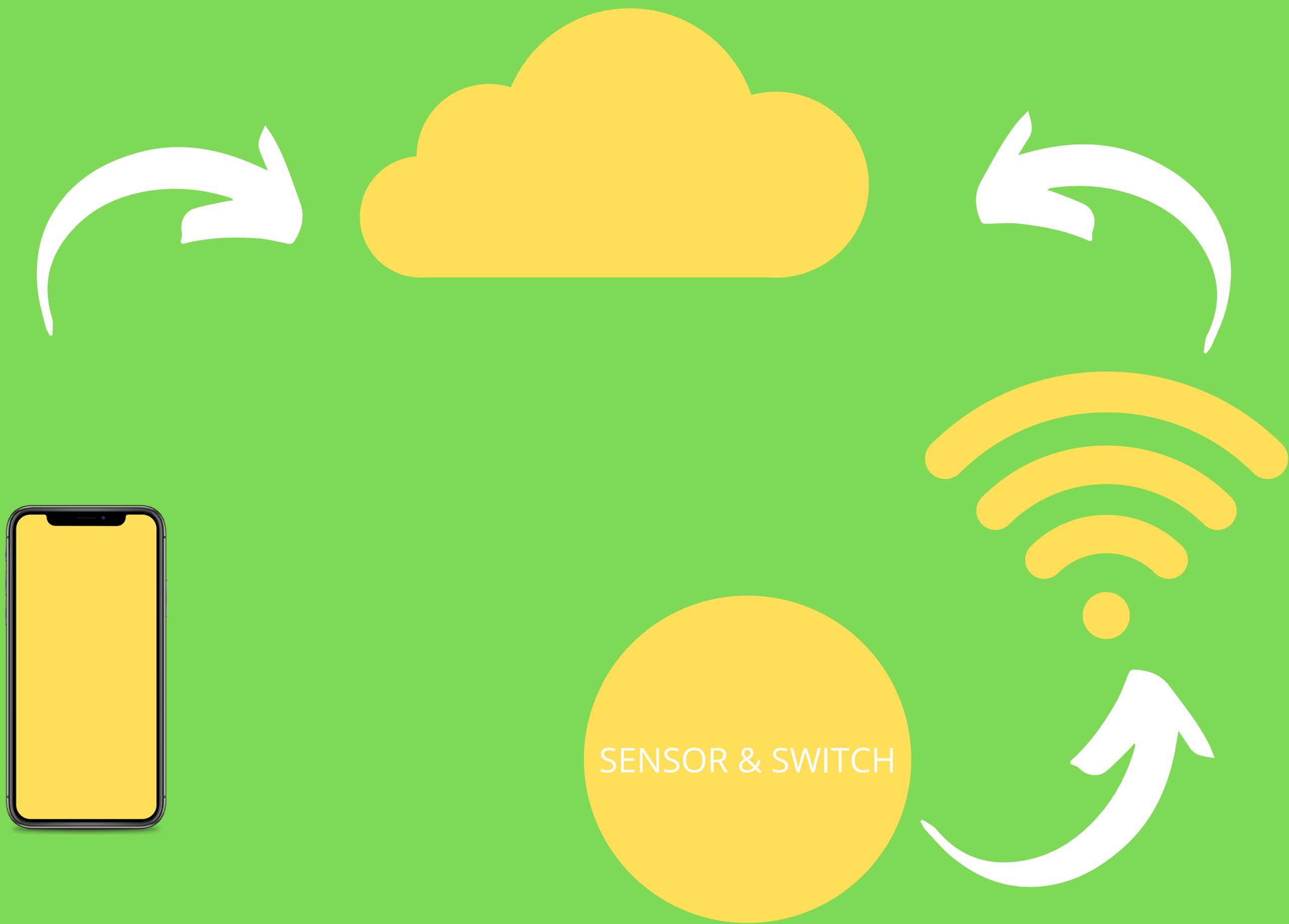

TERIMA KASIH

KKN-PPM UGM CANDIMULYO MAKARYO